



GYPNUM GRADINO 3 FR

Profilo in cartongesso progettato per realizzare una forma geometrica perimetrale in un controsoffitto in cartongesso.

Profilé en placoplâtre conçu pour réaliser une forme géométrique périmétrique dans une cloison en placoplâtre.

Spessore 12,5 mm	Épaisseur 12,5 mm
Lunghezza 2000 mm	Longueur 2000 mm

Richiesta profilo personalizzato.

Demande de profilé personnalisé.

INSERIRE MISURE / INSÉRER LES MESURES	
Tipo Lastra / Type Plaque	_____
Spessore / Épaisseur	_____ mm
Lunghezza / Longueur	_____ mm
A	_____ mm
B	_____ mm
C	_____ mm
D	_____ mm
E	_____ mm
F	_____ mm
INDICARE QUANTITÀ / INDIQUER QUANTITÉ	
Pezzi / Pièces	_____

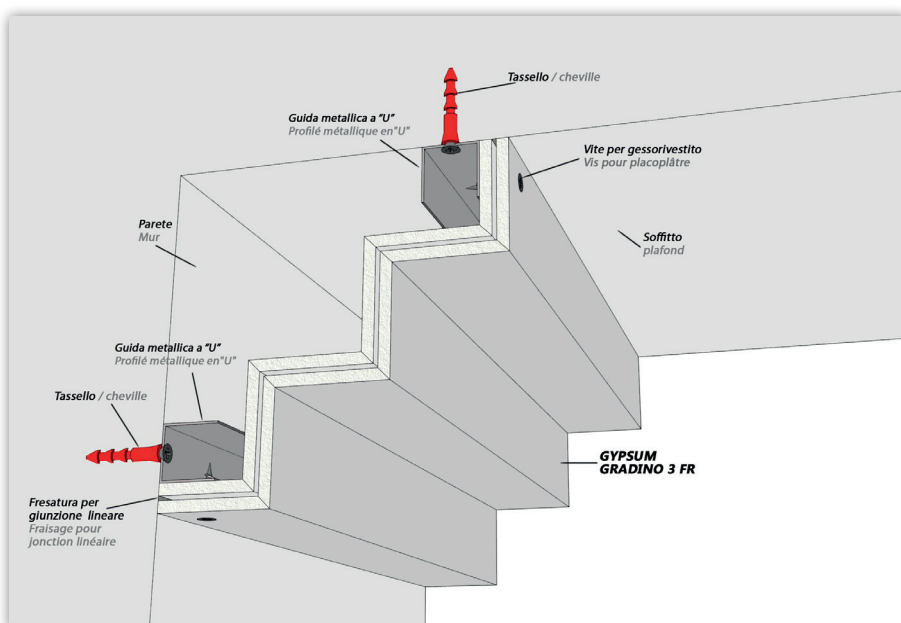
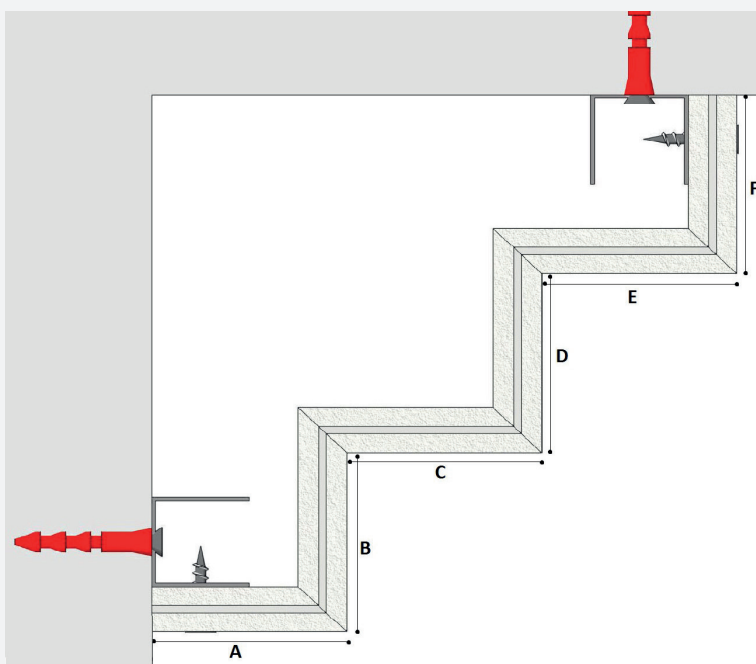

▼ **IMPORTANTE! IMPORTANT!**

È possibile, su richiesta, rifinire con un fondo monocomponente all'acqua di colore bianco la parte interna del profilo.

It is possible, on request, to finish the inner part of the profile with a white one-component water-based bottom.

COLLA POLIURETANICA
COLLE POLYURÉTHANE



CODICE / CODE	DESCRIZIONE / DESCRIPTION	PZ. PER CONFEZIONE PIÈCES PAR LOT	KG PER PEZZO KG PER PIECE	KG PER CONFEZIONE KG PAR LOT
col050pol	colla poliuretanic per giunti / colle polyuréthane pour joints	25	0,50	12,5

INSERTI LINEA GYPSUM
LINEA GYPSUM INSERTS



LINGUETTE
LANGUETTES



CODICE / CODE	DESCRIZIONE / DESCRIPTION	PZ. PER CONFEZIONE PIÈCES PAR LOT	KG PER CONFEZIONE KG PAR LOT
Ling60-50fres	linguette per giunti / languettes pour joints	50	0,15



FASE APPLICATIVA / PHASE D'APPLICATION

Giunto Lineare / Joint linéaire

Es: articolo GYPSUM DOPPIO CLASSICO FM 100 FR / Ex. article: GYPSUM DOPPIO CLASSICO FM 100 FR

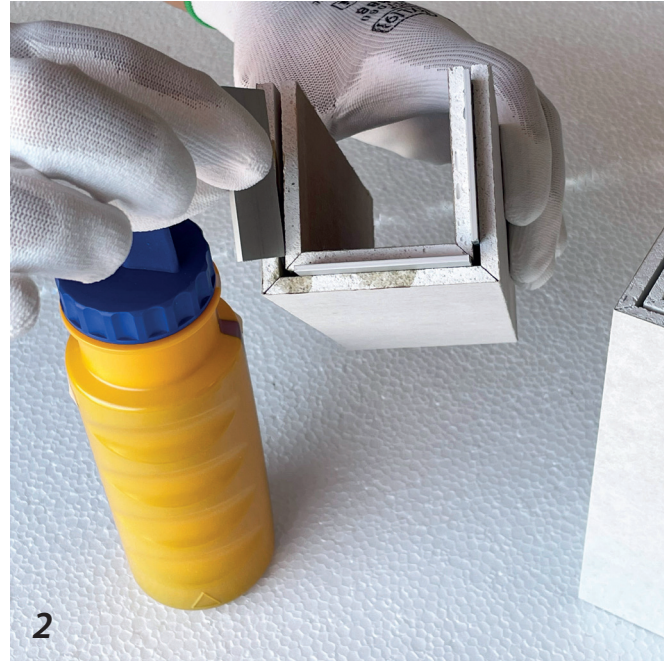
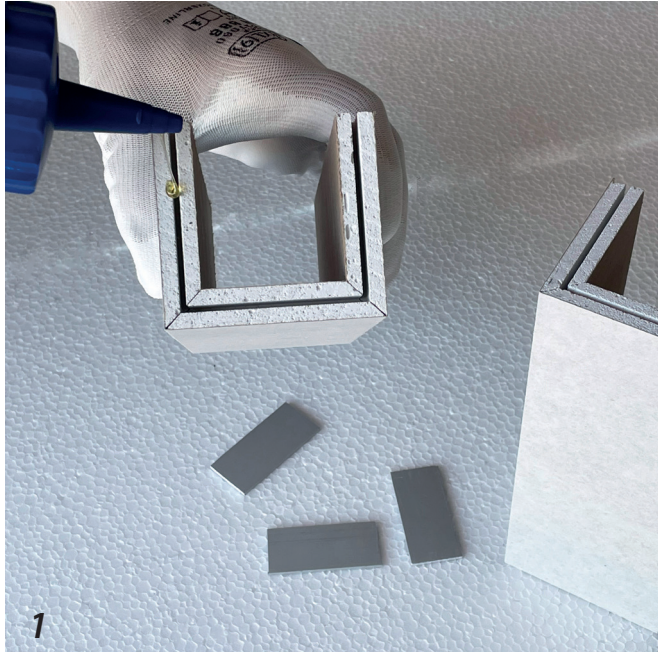

Applicare la colla poliuretana nella fresatura del profilo e successivamente apporre gli inserti in alluminio per giuntarlo con l'altro profilo.
Appliquer la colle de polyuréthane dans le fraisage du profilé et ensuite apposer les inserts en aluminium pour le raccorder à l'autre profilé.

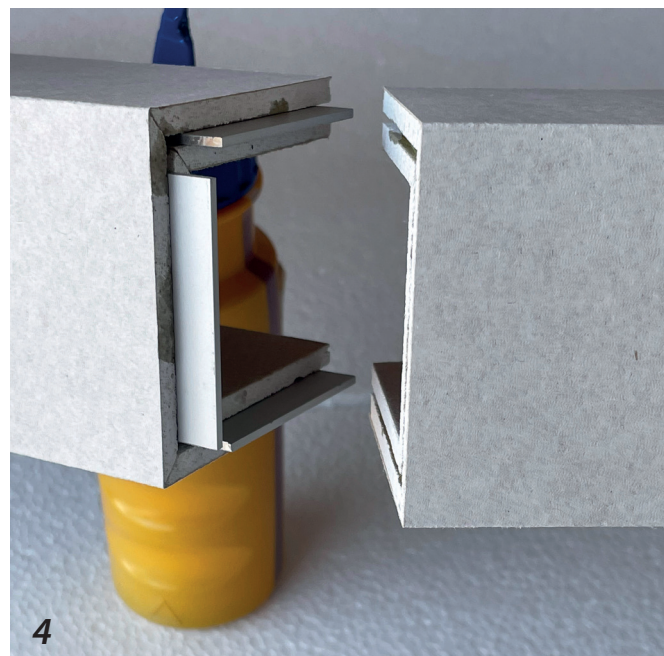
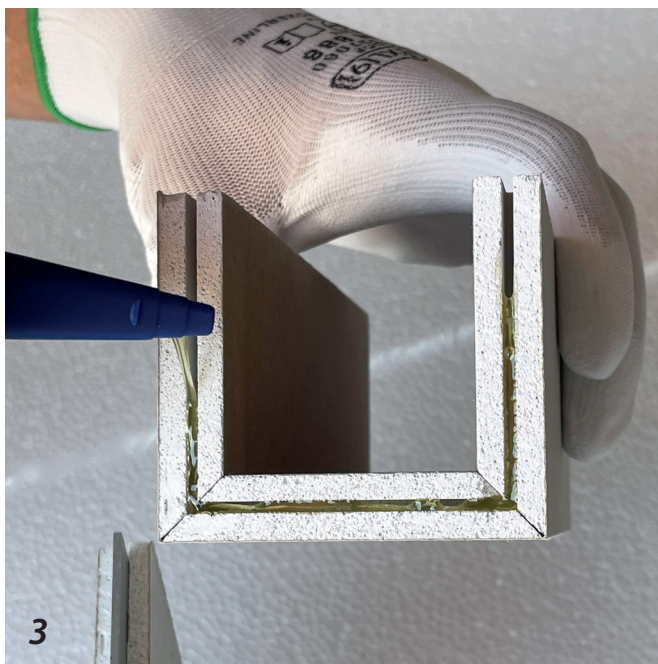

FASE APPLICATIVA / PHASE D'APPLICATION

Giunto Lineare / Joint linéaire

Es: articolo GYPSUM DOPPIO CLASSICO FM 100 FR / Ex: article GYPSUM DOPPIO CLASSICO FM 100 FR

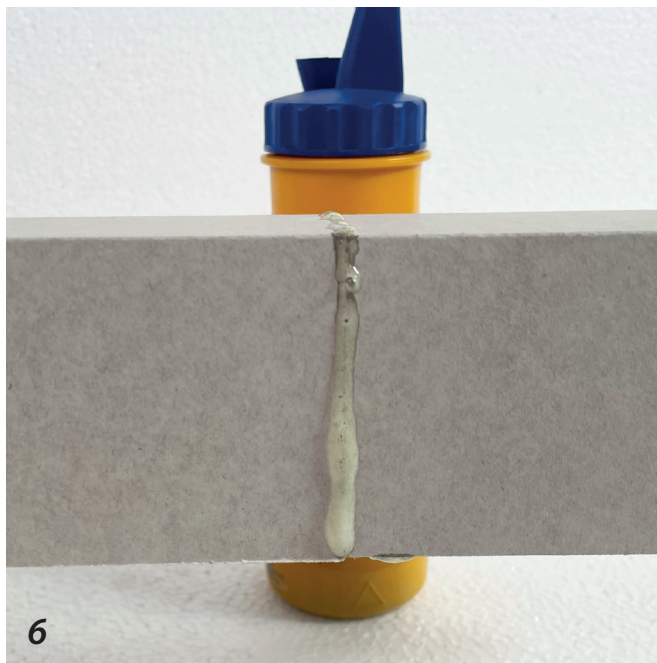
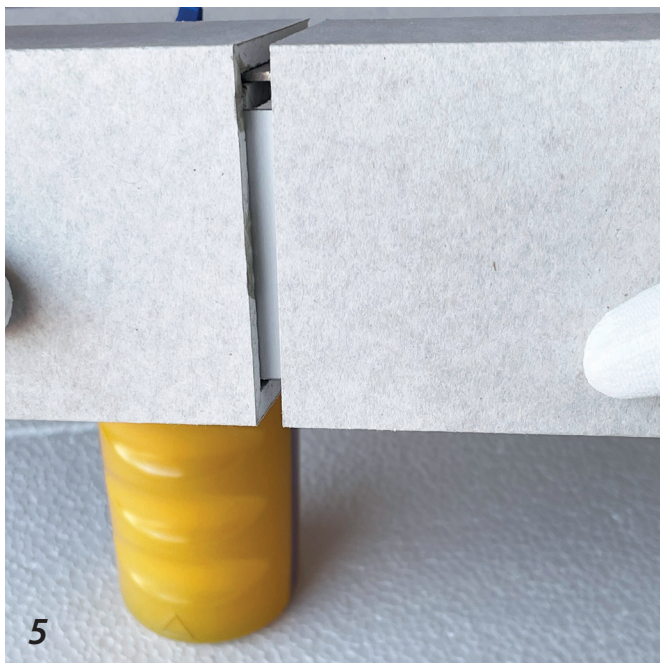

Poi inserire anche nell'altro profilo la colla poliuretanicca nella fresatura e infine unire i due profili incastrando fra di essi l'inserto in alluminio, attendere che asciughi la colla.

Ensuite, insérez également dans l'autre profilé la colle polyuréthane dans le fraisage et enfin joignez les deux profilés en insérant entre eux l'insert en aluminium, attendez que sèche la colle.

Giunto Lineare / Joint linéaire

Es: articolo GYPSUM MONOLASTRA FR / Ex: article GYPSUM MONOLASTRA FR

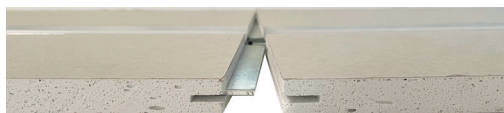
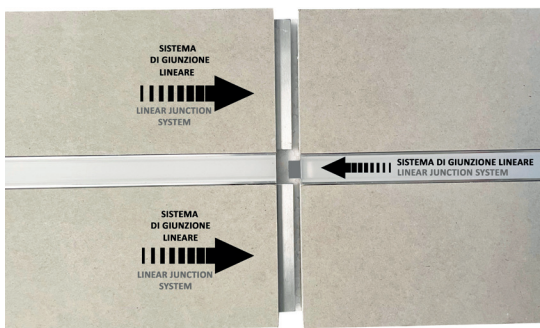

Colla poliuretanicca per l'incollaggio dei profili LINEA GYPSUM

Colle polyuréthane pour le collage des profils LINEA GYPSUM

LINGUETTE LINEA GYPSUM
LANGUETTES LINEA GYPSUM



LINGUETTE DISSIPATORE
LANGUETTES DISSIPATEUR



GYPSUM SPECIAL



L

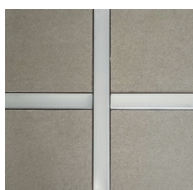

+



T

Ignilastra / Plaque ignifuge

Dissipatore in alluminio per STRIP LED max 14,4 W per ml
Dissipateur en aluminium pour STRIP LED max 14.4 W par ml

Copertura in metacrilato PMMA / Couverture en méthacrylate PMMA

Primo sistema di giunzione lineare anche sui pezzi speciali
Premier système de jonction linéaire même sur les pièces spéciales

Fatto in Italia / Fabriqué en Italy